

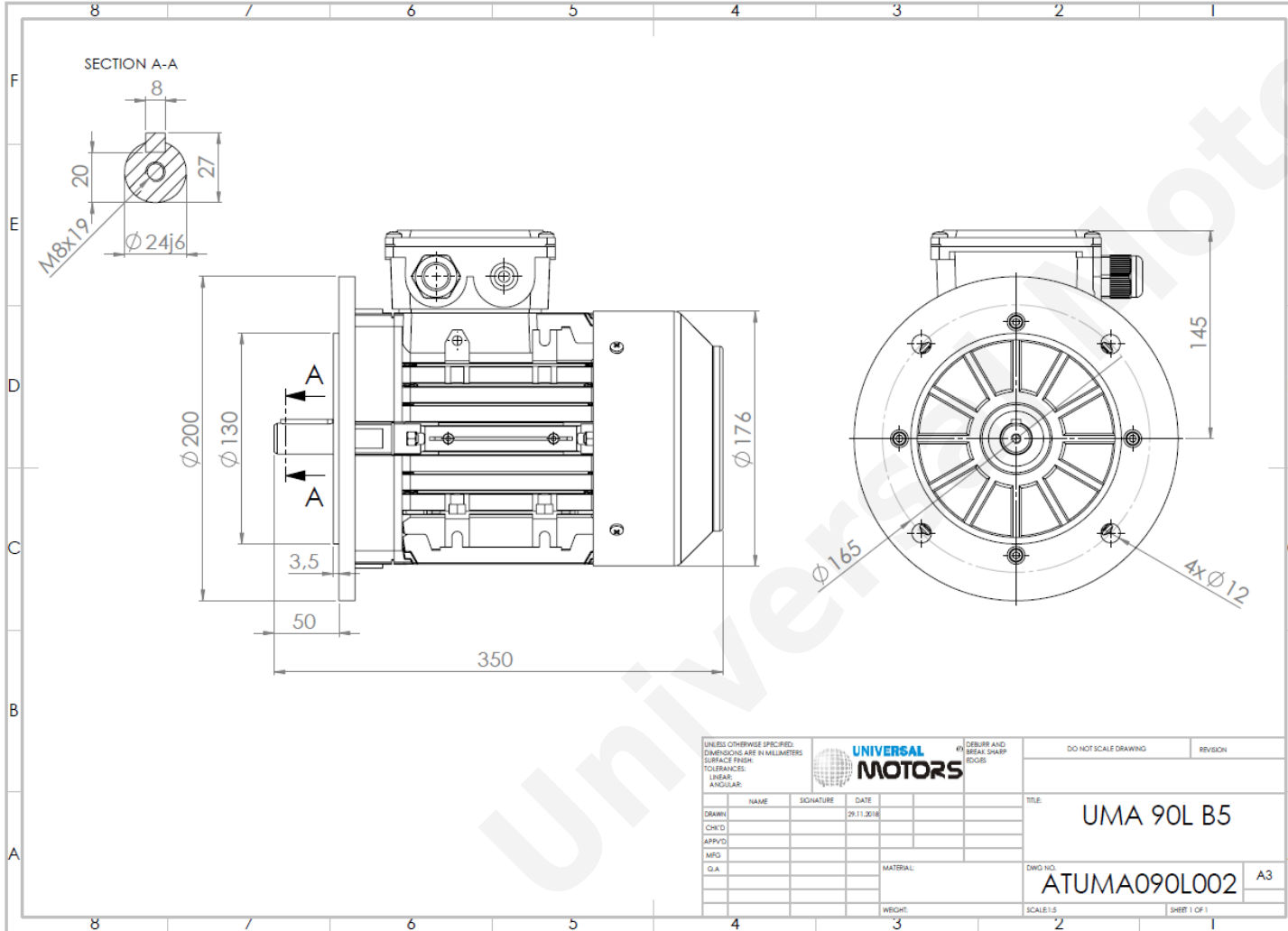

TECHNICAL DATA

Three Phase Electric Motors - Aluminum Frame
 UM2A 90L1-2
 2.2 kW / 3 Cv
 2890 RPM



Motor type:	UM2A 90L1-2
Output:	2.2 kW / 3 Cv
Speed (min ⁻¹):	2890 RPM
Frequency:	50 Hz
Voltage:	400 V
Current:	4.6 A
Power factor (Cos Ø):	0.83
Poles:	2
Insulation class:	F
Temperature rise Class:	B
Efficiency 50%:	82.1 %
Efficiency 75%:	83.8 %
Efficiency 100%:	83.2 %
Torque:	7.3 N.m
Tstarting/Tnominal:	2.8
Istarting/Inominal:	7.6
Tmaximum/Tnominal:	3.1
Noise:	72 Db(A)
Weight:	15.0 Kg
Brake AC:	AC4
Torque Brake DC:	16 N.m
Bearing DE:	6205 2Z
Bearing NDE:	6205 2Z
Torque Brake AC:	20 N.m
Brake DC:	REB-05-10

Regime - S1

Altitude - 1000m

Environment Temperature - 40°C

CONTACTS:

UNIVERSAL MOTORS Tel: +351 252 299 080
 Rua de São Brás,745 Fax: +351 252 299 089
 4480-782 VILA DO CONDE Mail: geral@universalmotors.pt

* References applied only in the UK